

Analog Peripherals

12-Bit ADC

- ± 1 LSB INL; no missing codes
- Programmable throughput up to 100 ksp/s
- 8 external inputs; programmable as single-ended or differential
- Programmable amplifier gain: 16, 8, 4, 2, 1, 0.5
- Data-dependent windowed interrupt generator
- Built-in temperature sensor (± 3 °C)

8-Bit ADC

- ± 1 LSB INL; no missing codes
- Programmable throughput up to 500 ksp/s
- 8 external inputs
- Programmable amplifier gain: 4, 2, 1, 0.5

Two 12-Bit DACs

- Can synchronize outputs to timers for jitter-free waveform generation

Two Comparators

Internal Voltage Reference

V_{DD} Monitor/Brown-out Detector

On-Chip JTAG Debug & Boundary Scan

- On-chip debug circuitry facilitates full speed, non-intrusive in-system debug (no emulator required)
- Provides breakpoints, single stepping, watchpoints, stack monitor
- Inspect/modify memory and registers
- Real-time instruction trace buffer
- IEEE1149.1 compliant boundary scan

High-Speed 8051 μ C Core

- Pipelined instruction architecture; executes 70% of instructions in 1 or 2 system clocks
- Up to 50 MIPS throughput with 50 MHz system clock
- Expanded interrupt handler

Memory

- 8448 bytes data RAM
- 128 kB Flash; in-system programmable in 1024-byte sectors (1024 bytes are reserved)
- External parallel data memory interface

Digital Peripherals

- 32 port I/O; all are 5 V tolerant
- Hardware SMBus™ (I2C™ compatible), SPI™, and two UART serial ports available concurrently
- Programmable 16-bit counter/timer array with six capture/compare modules
- 5 general-purpose 16-bit counter/timers
- Dedicated watchdog timer; bidirectional reset
- Real-time clock mode using a timer or PCA

Clock Sources

- Internal oscillator: 24.5 MHz, 2% accuracy supports UART operation
- On-chip programmable PLL: up to 50 MHz
- External oscillator: Crystal, RC, C, or Clock

Supply Voltage: 2.7 to 3.6 V

- Typical operating current: 25 mA at 50 MHz
- Typical stop mode current: <0.1 μ A

64-Pin TQFP

Temperature Range: -40 to +85 °C

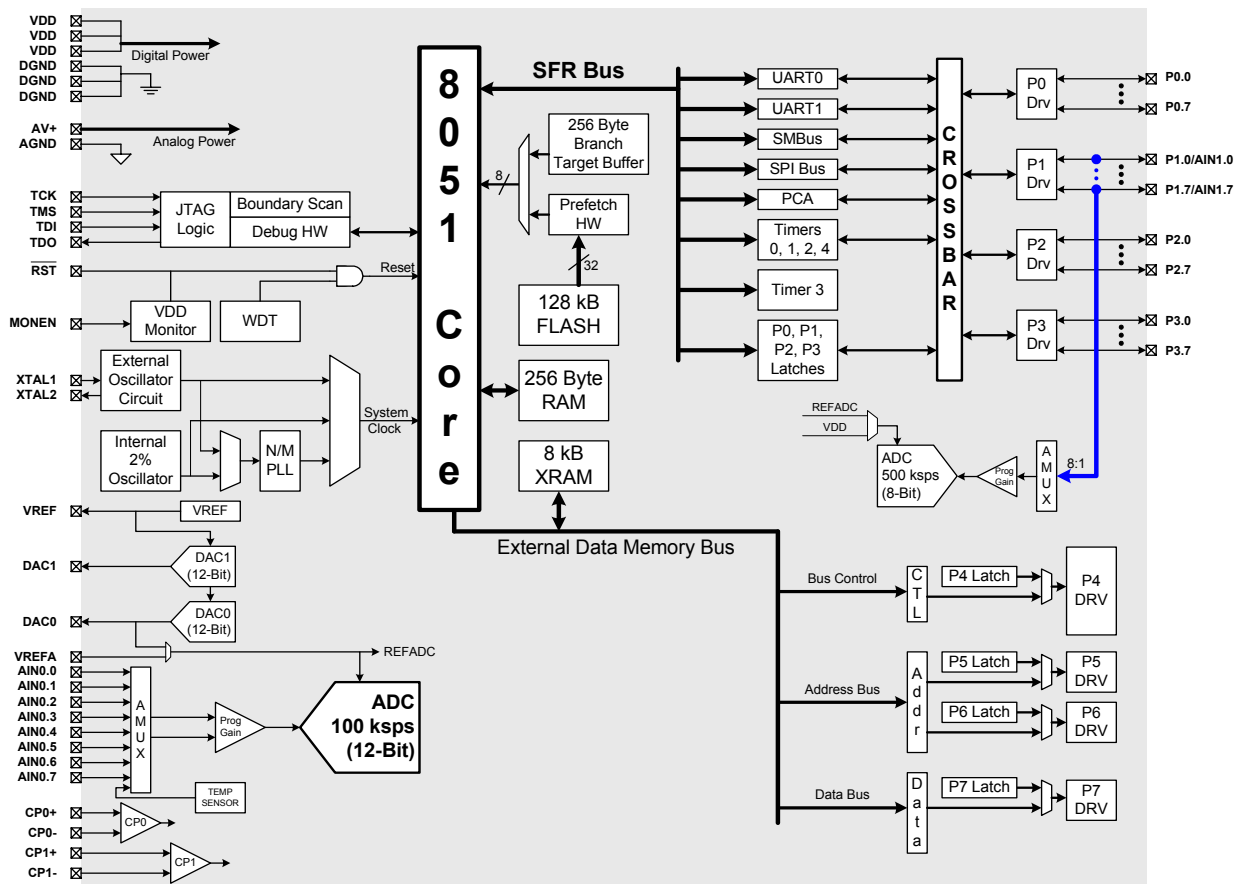

Selected Electrical Specifications

($T_A = -40$ to $+85$ °C, $V_{DD} = 2.7$ V unless otherwise specified)

PARAMETER	CONDITIONS	MIN	TYP	MAX	UNITS
GLOBAL CHARACTERISTICS					
Supply Voltage		2.7		3.6	V
Supply Current (CPU active)	Clock = 50 MHz Clock = 1 MHz Clock = 32 kHz		25 0.5 16		mA mA μA
Supply Current (shutdown)	Oscillator off; V_{DD} Monitor Enabled Oscillator off; V_{DD} Monitor Disabled		10 <0.1		μA μA
Clock Frequency Range		DC		50	MHz
INTERNAL CLOCKS					
Oscillator Frequency		24.0	24.5	25.0	MHz
PLL Frequency		48	49	50	MHz
A/D CONVERTER					
Resolution			12		bits
Integral Nonlinearity				±1	LSB
Differential Nonlinearity	Guaranteed Monotonic			±1	LSB
Signal-to-Noise Plus Distortion		66	69		dB
Throughput Rate				100	ksps
D/A CONVERTERS					
Resolution			12		bits
Differential Nonlinearity	Guaranteed Monotonic			±1	LSB
Output Settling Time			10		μS
COMPARATORS					
Supply Current	(each Comparator)		1.5		μA
Response Time	(CP+) – (CP-) = 100 mV		4.0		μS

Package Information

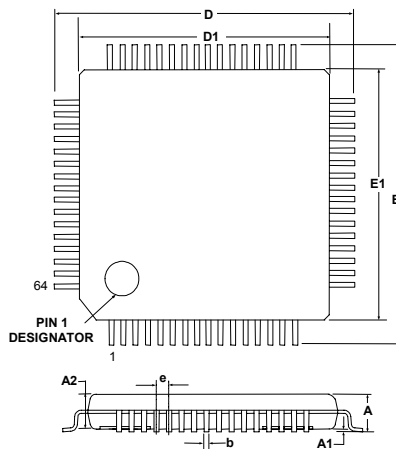

	MIN (mm)	NOM (mm)	MAX (mm)
A	-	-	1.20
A1	0.05	-	0.15
A2	0.95	-	1.05
b	0.17	0.22	0.27
D	-	12.00	-
D1	-	10.00	-
e	-	0.50	-
E	-	12.00	-
E1	-	10.00	-

C8051F120DK Development Kit

