



N-Channel Enhancement-Mode Vertical DMOS FET Quad Array

Ordering Information

BV_{DSS} / BV_{DGS}	$R_{DS(ON)} \text{ Max}$	Order Number / Package
		SOW-20*
40V	1.0Ω	TN0604WG

* Same as SO-20 with 300 mil wide body.

Features

- 4 independent channels
- 4 electrically isolated die
- Commercial and military versions available
- Free from secondary breakdown
- Low power drive requirement
- Low C_{ISS} and fast switching speeds
- High input impedance and high gain

Applications

- Logic level interfaces – ideal for TTL and CMOS
- Solid state relays
- Battery operated systems
- Photo voltaic drives
- Analog switches
- General purpose line drivers
- Telecom switches

Absolute Maximum Ratings

Drain-to-Source Voltage	BV_{DSS}
Drain-to-Gate Voltage	BV_{DGS}
Gate-to-Source Voltage	$\pm 20V$
Operating and Storage Temperature	$-55^{\circ}C$ to $+150^{\circ}C$
Soldering Temperature*	$300^{\circ}C$

* Distance of 1.6 mm from case for 10 seconds.

Advanced DMOS Technology

These enhancement-mode (normally-off) DMOS FET arrays utilize a vertical DMOS structure and Supertex's well-proven silicon-gate manufacturing process. This combination produces devices with the power handling capabilities of bipolar transistors and with the high input impedance and positive temperature coefficient inherent in MOS devices. Characteristic of all MOS structures, these devices are free from thermal runaway and thermally-induced secondary breakdown.

Supertex quad arrays use four independent DMOS transistors. They are ideally suited to a wide range of switching and amplifying applications where high breakdown voltage, high input impedance, low input capacitance, and fast switching speeds are desired.

Pin Configuration

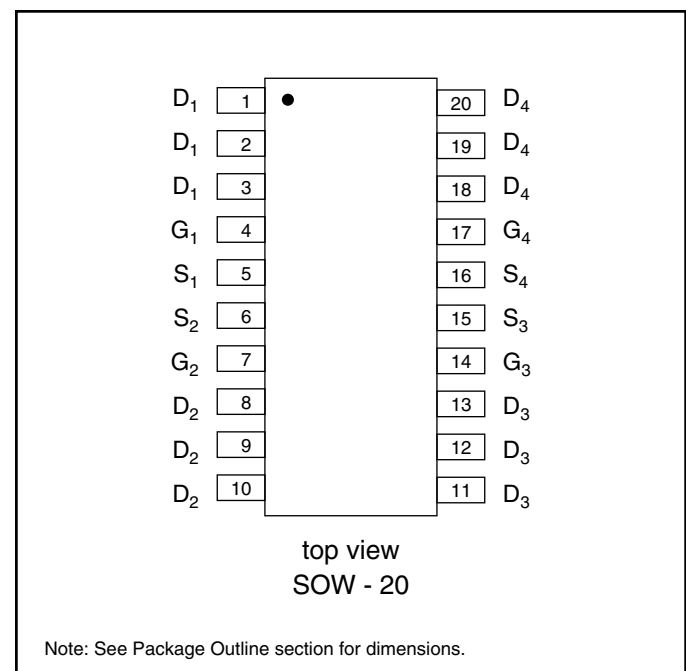

Thermal Characteristics

Package	I_D (continuous)* (single die)	I_D (pulsed)	Power Dissipation @ $T_A = 25^\circ\text{C}$	θ_{jc} $^\circ\text{C/W}$	θ_{ja} $^\circ\text{C/W}$	I_{DR}^* (single die)	I_{DRM}
SOW-20	1.0A	4.0A	1.5W	—	84	1.0A	4.0A

* I_D (continuous) is limited by max rated T_j .

Electrical Characteristics (@ 25°C unless otherwise specified)

Symbol	Parameter	Min	Typ	Max	Unit	Conditions
BV_{DSS}	Drain-to-Source Breakdown Voltage	40			V	$V_{GS} = 0V, I_D = 2.0mA$
$V_{GS(th)}$	Gate Threshold Voltage	0.6		1.6	V	$V_{GS} = V_{DS}, I_D = 1.0mA$
$\Delta V_{GS(th)}$	Change in $V_{GS(th)}$ with Temperature		-3.8	-4.5	mV/ $^\circ\text{C}$	$V_{GS} = V_{DS}, I_D = 1mA$
I_{GSS}	Gate Body Leakage			100	nA	$V_{GS} = \pm 20V, V_{DS} = 0V$
I_{DSS}	Zero Gate Voltage Drain Current			10	μA	$V_{GS} = 0V, V_{DS} = \text{Max Rating}$
				1.0	mA	$V_{GS} = 0V, V_{DS} = 0.8 \text{ Max Rating}$ $T_A = 125^\circ\text{C}$
$I_{D(ON)}$	ON-State Drain Current	1.5	2.1		A	$V_{GS} = 5V, V_{DS} = 20V$
		4.0	7.0			$V_{GS} = 10V, V_{DS} = 20V$
$R_{DS(ON)}$	Static Drain-to-Source ON-State Resistance		1.0	1.6	Ω	$V_{GS} = 5V, I_D = 0.75A$
				1.0	Ω	$V_{GS} = 10V, I_D = 1.5A$
$\Delta R_{DS(ON)}$	Change in $R_{DS(ON)}$ with Temperature		0.5	0.75	%/ $^\circ\text{C}$	$V_{GS} = 10V, I_D = 1.5A$
G_{FS}	Forward Transconductance	0.5	0.8		S	$V_{DS} = 20V, I_D = 1.5A$
C_{ISS}	Input Capacitance		140	190	pF	$V_{GS} = 0V, V_{DS} = 20V$ $f = 1 \text{ MHz}$
C_{OSS}	Common Source Output Capacitance		75	110		
C_{RSS}	Reverse Transfer Capacitance		25	50		
$t_{d(ON)}$	Turn-ON Delay Time			10	ns	$V_{DD} = 20V$ $I_D = 0.5A$ $R_{GEN} = 25\Omega$
t_r	Rise Time			6.0		
$t_{d(OFF)}$	Turn-OFF Delay Time			25		
t_f	Fall Time			20		
V_{SD}	Diode Forward Voltage Drop		1.2	1.8	V	$V_{GS} = 0V, I_{SD} = 1.5A$
t_{rr}	Reverse Recovery Time		300		ns	$V_{GS} = 0V, I_{SD} = 1A$

Notes:

- All D.C. parameters 100% tested at 25°C unless otherwise stated. (Pulse test: 300 μs pulse, 2% duty cycle.)
- All A.C. parameters sample tested.

Switching Waveforms and Test Circuit

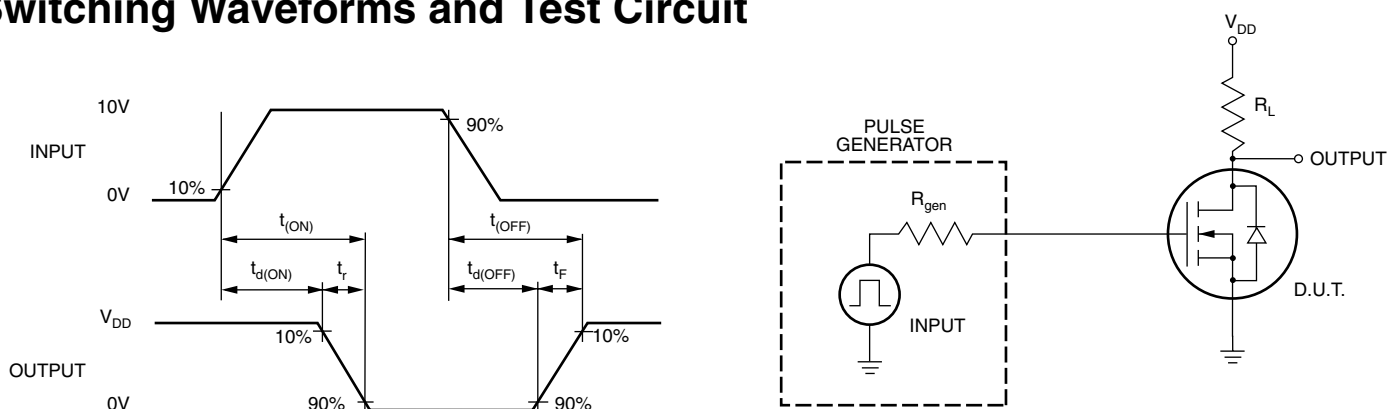

Typical Performance Curves

Output Characteristics

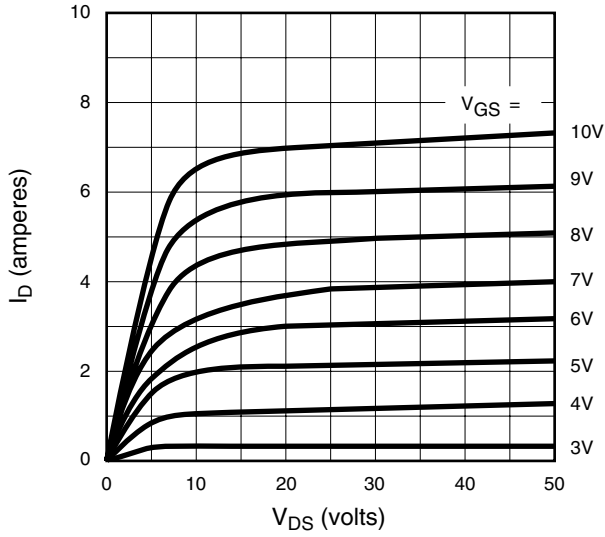

Saturation Characteristics

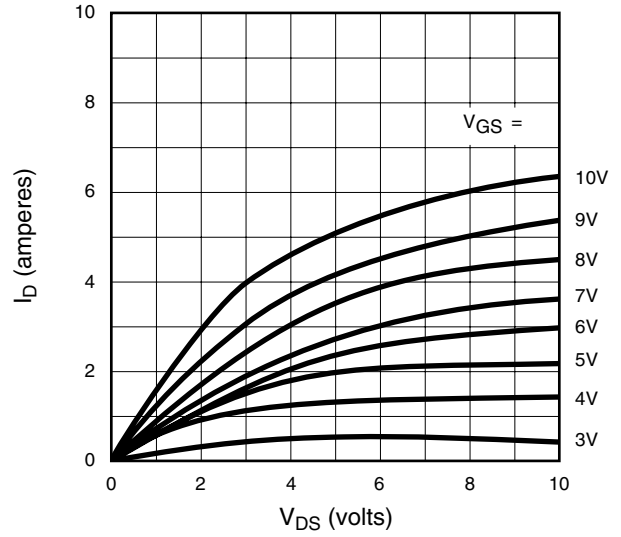

Transconductance vs. Drain Current

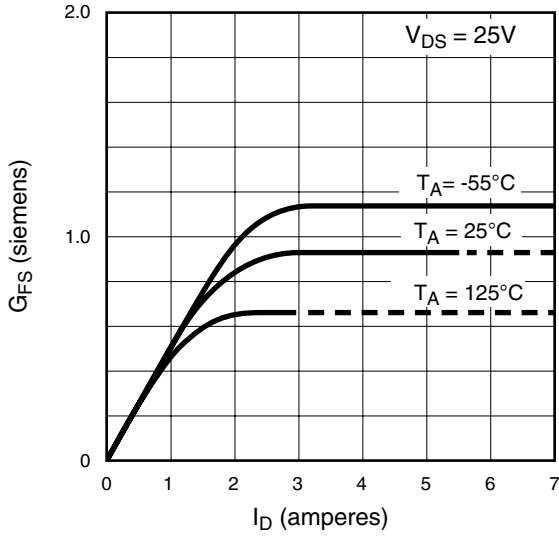

Power Dissipation vs. Ambient Temperature

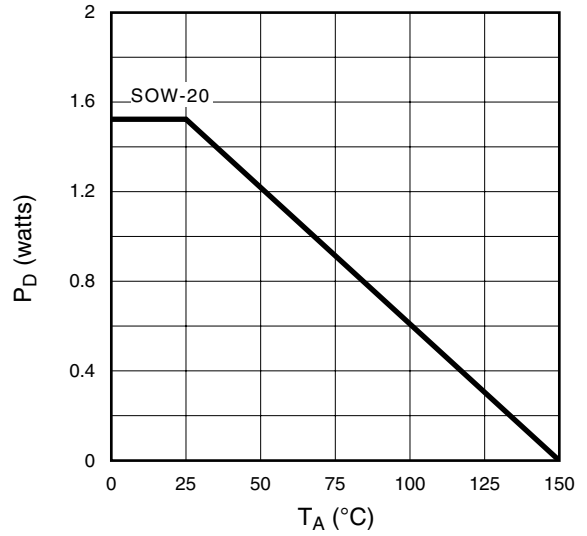

Maximum Rated Safe Operating Area

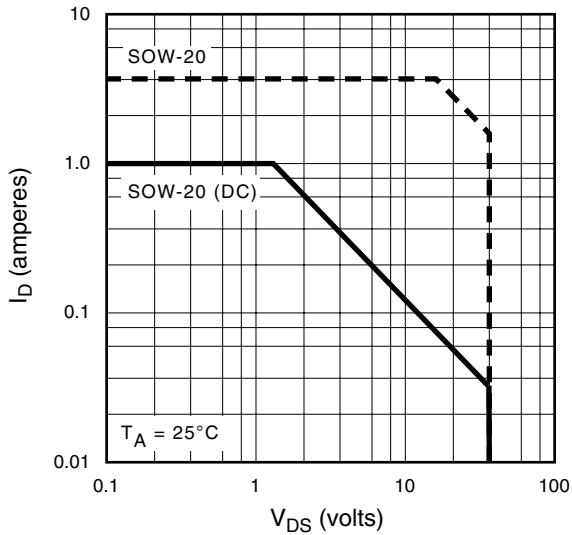

Typical Performance Curves

BV_{DSS} Variation with Temperature

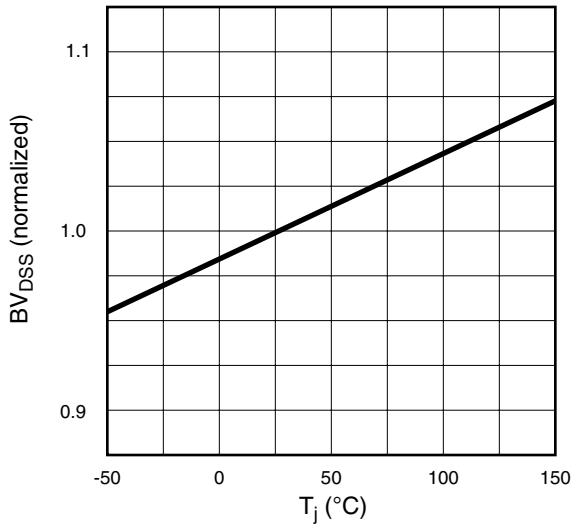

On-Resistance vs. Drain Current

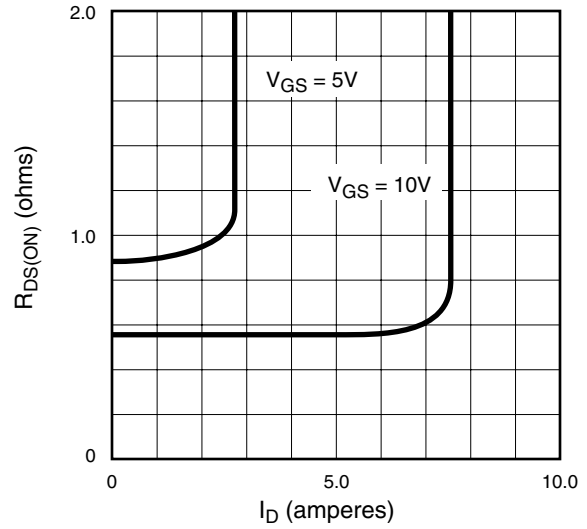

Transfer Characteristics

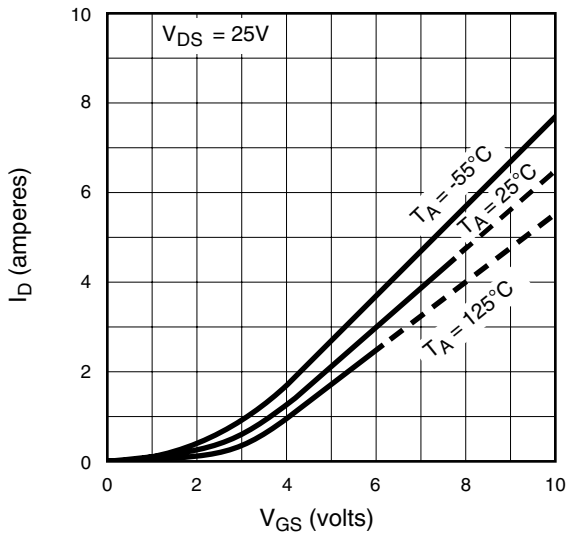

V_(th) and R_{DS} Variation with Temperature

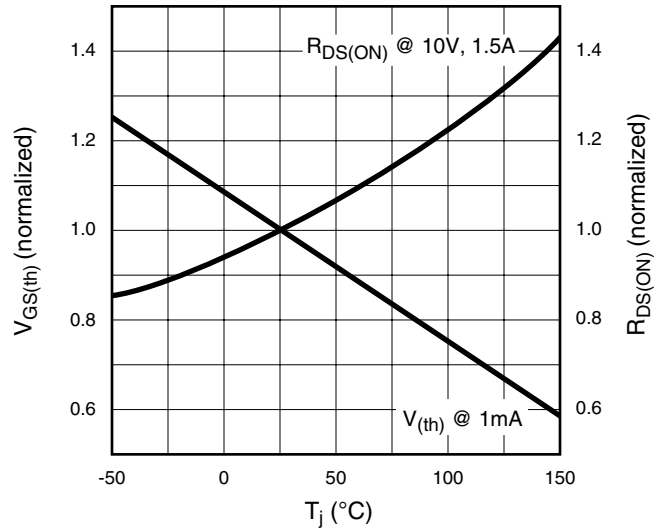

Capacitance vs. Drain-to-Source Voltage

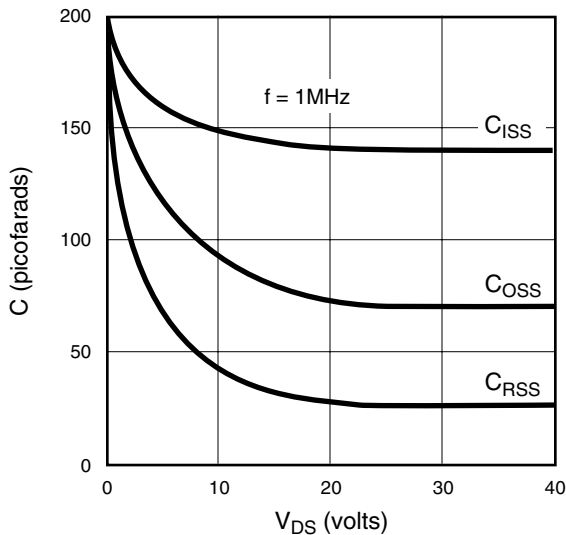

Gate Drive Dynamic Characteristics

