



**N-Channel Enhancement-Mode
Vertical DMOS FETs**

Ordering Information

BV _{DSS} / BV _{DGS}	R _{DS(ON)} (max)	V _{GS(th)} (max)	I _{D(ON)} (min)	Order Number / Package	
				TO-243AA*	Die†
100V	1.5Ω	2.0V	3.0A	TN2510N8	TN2510ND

* Same as SOT-89. Product supplied on 2000 piece carrier tape reels.

† MIL visual screening available.

Product marking for TO-243AA:

TN5A*

Where * = 2-week alpha date code

Features

- Low threshold —2.0V max.
- High input impedance
- Low input capacitance — 125pF max.
- Fast switching speeds
- Low on resistance
- Free from secondary breakdown
- Low input and output leakage
- Complementary N- and P-channel devices

Low Threshold DMOS Technology

These low threshold enhancement-mode (normally-off) transistors utilize a vertical DMOS structure and Supertex's well-proven silicon-gate manufacturing process. This combination produces devices with the power handling capabilities of bipolar transistors and with the high input impedance and positive temperature coefficient inherent in MOS devices. Characteristic of all MOS structures, these devices are free from thermal runaway and thermally-induced secondary breakdown.

Supertex's vertical DMOS FETs are ideally suited to a wide range of switching and amplifying applications where very low threshold voltage, high breakdown voltage, high input impedance, low input capacitance, and fast switching speeds are desired.

Applications

- Logic level interfaces – ideal for TTL and CMOS
- Solid state relays
- Battery operated systems
- Photo voltaic drives
- Analog switches
- General purpose line drivers
- Telecom switches

Package Option

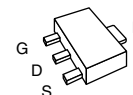

TO-243AA
(SOT-89)

Note: See Package Outline section for dimensions.

Absolute Maximum Ratings

Drain-to-Source Voltage	BV _{DSS}
Drain-to-Gate Voltage	BV _{DGS}
Gate-to-Source Voltage	± 20V
Operating and Storage Temperature	-55°C to +150°C
Soldering Temperature*	300°C

* Distance of 1.6 mm from case for 10 seconds.

11/12/01

Thermal Characteristics

Package	I _D (continuous)*	I _D (pulsed)	Power Dissipation @ T _A = 25°C	θ _{Jc} °C/W	θ _{Ja} °C/W	I _{DR} *	I _{DRM}
TO-243AA	0.73A	5.0A	1.6W†	15	78†	0.73A	5.0A

* I_D (continuous) is limited by max rated T_J.

† Mounted on FR5 board, 25mm x 25mm x 1.57mm. Significant P_D increase possible on ceramic substrate.

Electrical Characteristics (@ 25°C unless otherwise specified)

Symbol	Parameter	Min	Typ	Max	Unit	Conditions
BV _{DSS}	Drain-to-Source Breakdown Voltage	100			V	V _{GS} = 0V, I _D = 2mA
V _{GS(th)}	Gate Threshold Voltage	0.6		2.0	V	V _{GS} = V _{DS} , I _D = 1mA
ΔV _{GS(th)}	Change in V _{GS(th)} with Temperature			-4.5	mV/°C	V _{GS} = V _{DS} , I _D = 1.0mA
I _{GSS}	Gate Body Leakage			100	nA	V _{GS} = ± 20V, V _{DS} = 0V
I _{DSS}	Zero Gate Voltage Drain Current			10	μA	V _{GS} = 0V, V _{DS} = Max Rating
				1.0	mA	V _{GS} = 0V, V _{DS} = 0.8 Max Rating T _A = 125°C
I _{D(ON)}	ON-State Drain Current	1.2	2.0		A	V _{GS} = 5.0V, V _{DS} = 25V
		3.0	6.0			V _{GS} = 10V, V _{DS} = 25V
R _{DS(ON)}	Static Drain-to-Source ON-State Resistance			15	Ω	V _{GS} = 3.0V, I _D = 250mA
			1.5	2.0		V _{GS} = 4.5V, I _D = 750mA
		1.0	1.5	V _{GS} = 10V, I _D = 750mA		
ΔR _{DS(ON)}	Change in R _{DS(ON)} with Temperature			0.75	%/°C	V _{GS} = 10V, I _D = 750mA
G _{FS}	Forward Transconductance	0.4	0.8		S	V _{DS} = 25V, I _D = 1.0A
C _{ISS}	Input Capacitance		70	125	pF	V _{GS} = 0V, V _{DS} = 25V f = 1 MHz
C _{OSS}	Common Source Output Capacitance		30	70		
C _{RSS}	Reverse Transfer Capacitance		15	25		
t _{d(ON)}	Turn-ON Delay Time			10	ns	V _{DD} = 25V, I _D = 1.5A, R _{GEN} = 25Ω
t _r	Rise Time			10		
t _{d(OFF)}	Turn-OFF Delay Time			20		
t _f	Fall Time			10		
V _{SD}	Diode Forward Voltage Drop			1.8	V	V _{GS} = 0V, I _{SD} = 1.5A
t _{rr}	Reverse Recovery Time		300		ns	V _{GS} = 0V, I _{SD} = 1.5A

Notes:

1. All D.C. parameters 100% tested at 25°C unless otherwise stated. (Pulse test: 300μs pulse, 2% duty cycle.)
2. All A.C. parameters sample tested.

Switching Waveforms and Test Circuit

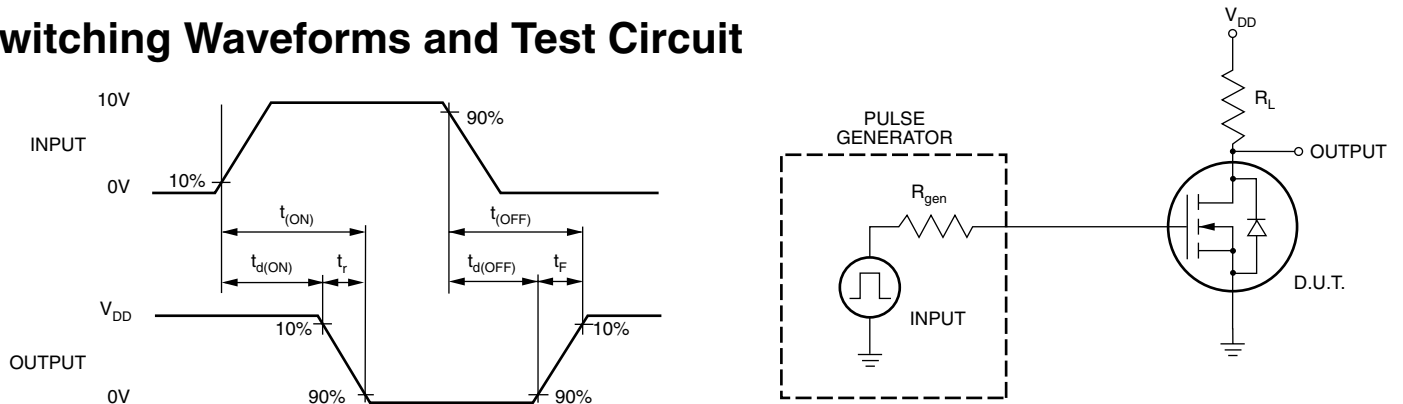

Typical Performance Curves

Output Characteristics

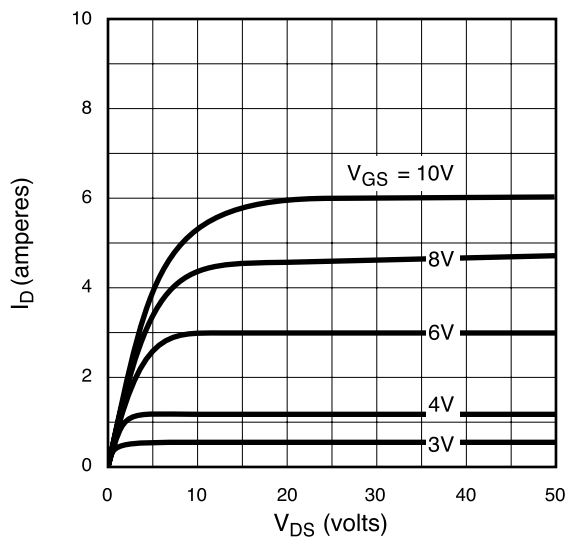

Saturation Characteristics

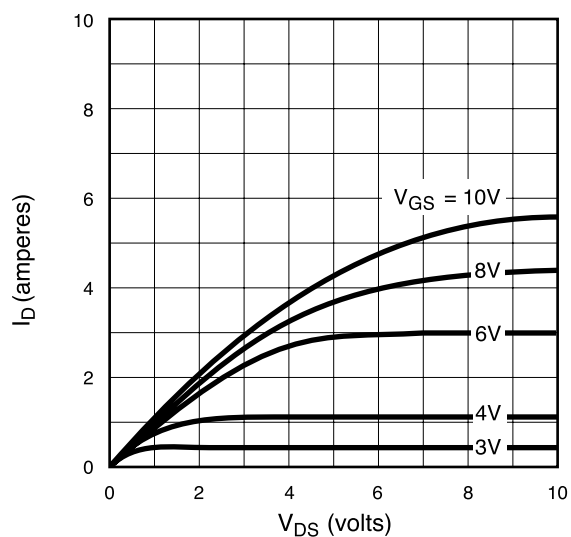

Transconductance vs. Drain Current

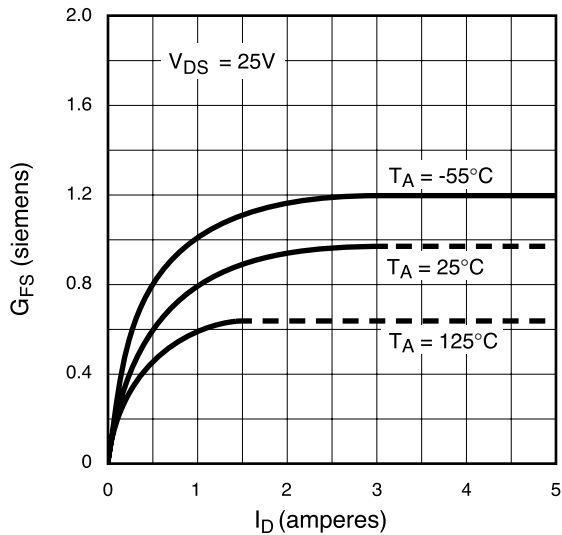

Power Dissipation vs. Ambient Temperature

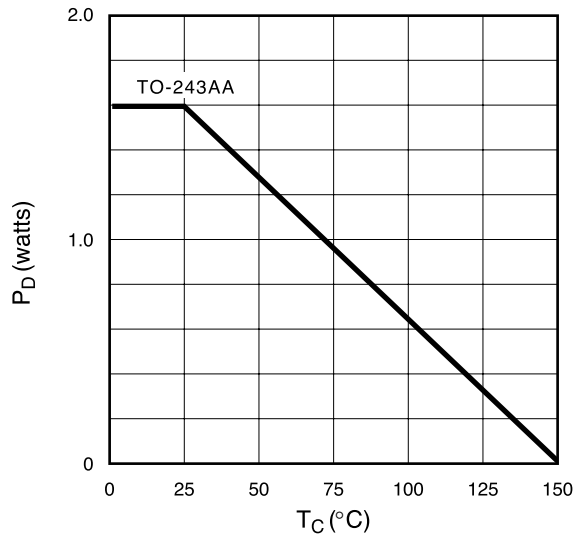

Maximum Rated Safe Operating Area

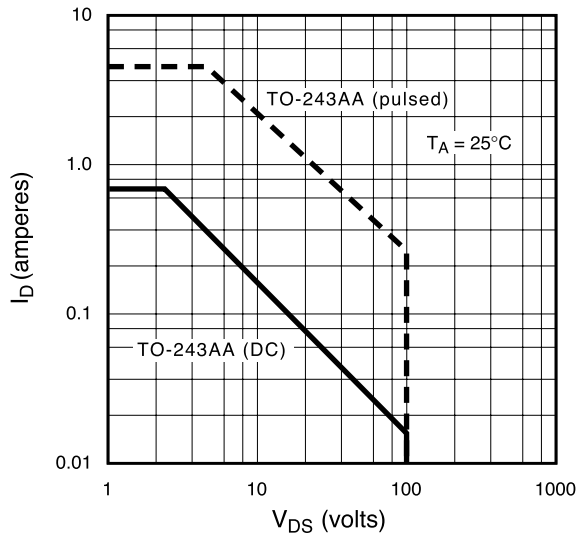

Thermal Response Characteristics

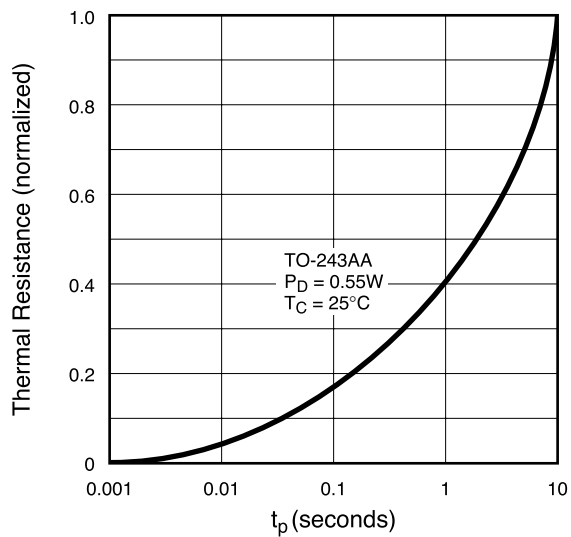

Typical Performance Curves

