



## P-Channel Enhancement-Mode Vertical DMOS FETs

### Ordering Information

BV <sub>DSS</sub> / BV <sub>DGS</sub>	R <sub>DS(ON)</sub> (max)	I <sub>D(ON)</sub> (min)	V <sub>GS(th)</sub> (max)	Order Number / Package
				TO-92
-200V	12Ω	-0.75A	-2.4V	TP0620N3

† MIL visual screening available

### Features

- Low threshold — -2.4 V max
- High input impedance
- Low input capacitance — 85pF typical
- Fast switching speeds
- Low on resistance
- Free from secondary breakdown
- Low input and output leakage
- Complementary N- and P-channel devices

### Low Threshold DMOS Technology

These low threshold enhancement-mode (normally-off) transistors utilize a vertical DMOS structure and Supertex's well-proven silicon-gate manufacturing process. This combination produces devices with the power handling capabilities of bipolar transistors and with the high input impedance and positive temperature coefficient inherent in MOS devices. Characteristic of all MOS structures, these devices are free from thermal runaway and thermally-induced secondary breakdown.

Supertex's vertical DMOS FETs are ideally suited to a wide range of switching and amplifying applications where very low threshold voltage, high breakdown voltage, high input impedance, low input capacitance, and fast switching speeds are desired.

### Applications

- Logic level interfaces – ideal for TTL and CMOS
- Solid state relays
- Battery operated systems
- Photo voltaic drives
- Analog switches
- General purpose line drivers
- Telecom switches

### Absolute Maximum Ratings

Drain-to-Source Voltage	BV <sub>DSS</sub>
Drain-to-Gate Voltage	BV <sub>DGS</sub>
Gate-to-Source Voltage	± 20V
Operating and Storage Temperature	-55°C to +150°C
Soldering Temperature*	300°C

\* Distance of 1.6 mm from case for 10 seconds.

### Package Option

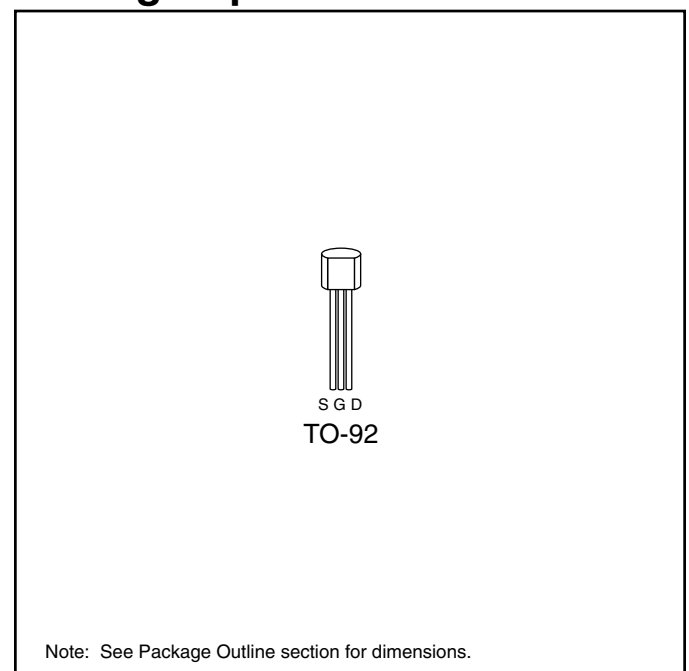

# Thermal Characteristics

Package	I <sub>D</sub> (continuous)*	I <sub>D</sub> (pulsed)	Power Dissipation @ T <sub>C</sub> = 25°C	θ <sub>jc</sub> °C/W	θ <sub>ja</sub> °C/W	I <sub>DR</sub> *	I <sub>DRM</sub>
TO-92	-175mA	-0.8A	1W	125	170	-175mA	-0.8A

\* I<sub>D</sub> (continuous) is limited by max rated T<sub>j</sub>.

# Electrical Characteristics (@ 25°C unless otherwise specified)

Symbol	Parameter	Min	Typ	Max	Unit	Conditions
BV <sub>DSS</sub>	Drain-to-Source Breakdown Voltage	-200			V	V <sub>GS</sub> = 0V, I <sub>D</sub> = -2.0mA
V <sub>GS(th)</sub>	Gate Threshold Voltage	-1.0		-2.4	V	V <sub>GS</sub> = V <sub>DS</sub> , I <sub>D</sub> = -1.0mA
ΔV <sub>GS(th)</sub>	Change in V <sub>GS(th)</sub> with Temperature			-4.5	mV/°C	V <sub>GS</sub> = V <sub>DS</sub> , I <sub>D</sub> = -1.0mA
I <sub>GSS</sub>	Gate Body Leakage			-100	nA	V <sub>GS</sub> = ±20V, V <sub>DS</sub> = 0V
I <sub>DSS</sub>	Zero Gate Voltage Drain Current			-10	μA	V <sub>GS</sub> = 0V, V <sub>DS</sub> = Max Rating
				-1.0	mA	V <sub>GS</sub> = 0V, V <sub>DS</sub> = 0.8 Max Rating T <sub>A</sub> = 125°C
I <sub>D(ON)</sub>	ON-State Drain Current	-0.25			A	V <sub>GS</sub> = -5V, V <sub>DS</sub> = -25V
		-0.75				V <sub>GS</sub> = -10V, V <sub>DS</sub> = -25V
R <sub>DS(ON)</sub>	Static Drain-to-Source ON-State Resistance		9.0	15	Ω	V <sub>GS</sub> = -5V, I <sub>D</sub> = -0.1A
			7.0	12		V <sub>GS</sub> = -10V, I <sub>D</sub> = -0.2A
ΔR <sub>DS(ON)</sub>	Change in R <sub>DS(ON)</sub> with Temperature			1.7	%/°C	V <sub>GS</sub> = -10V, I <sub>D</sub> = -0.2A
G <sub>FS</sub>	Forward Transconductance	100	150		mS	V <sub>DS</sub> = -25V, I <sub>D</sub> = -0.4A
C <sub>ISS</sub>	Input Capacitance		85	150	pF	V <sub>GS</sub> = 0V, V <sub>DS</sub> = -25V f = 1 MHz
C <sub>OSS</sub>	Common Source Output Capacitance		30	85		
C <sub>RSS</sub>	Reverse Transfer Capacitance		10	35		
t <sub>d(ON)</sub>	Turn-ON Delay Time			10	ns	V <sub>DD</sub> = -25V I <sub>D</sub> = -0.75A R <sub>GEN</sub> = 25Ω
t <sub>r</sub>	Rise Time			15		
t <sub>d(OFF)</sub>	Turn-OFF Delay Time			20		
t <sub>f</sub>	Fall Time			16		
V <sub>SD</sub>	Diode Forward Voltage Drop			-1.8	V	V <sub>GS</sub> = 0V, I <sub>SD</sub> = -0.5A
t <sub>rr</sub>	Reverse Recovery Time		300		ns	V <sub>GS</sub> = 0V, I <sub>SD</sub> = -0.5A

**Notes:**

1. All D.C. parameters 100% tested at 25°C unless otherwise stated. (Pulse test: 300μs pulse, 2% duty cycle.)
2. All A.C. parameters sample tested.

# Switching Waveforms and Test Circuit

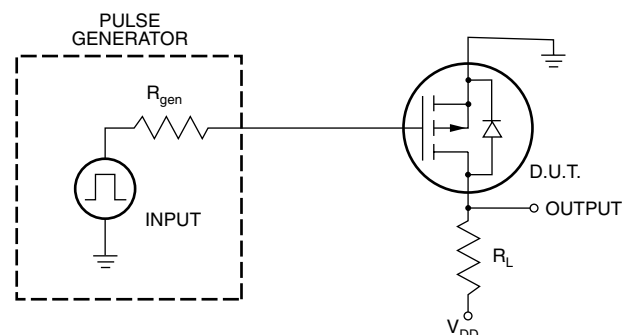
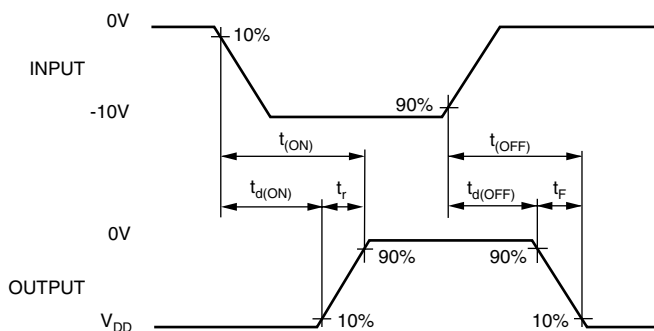

# Typical Performance Curves

Output Characteristics

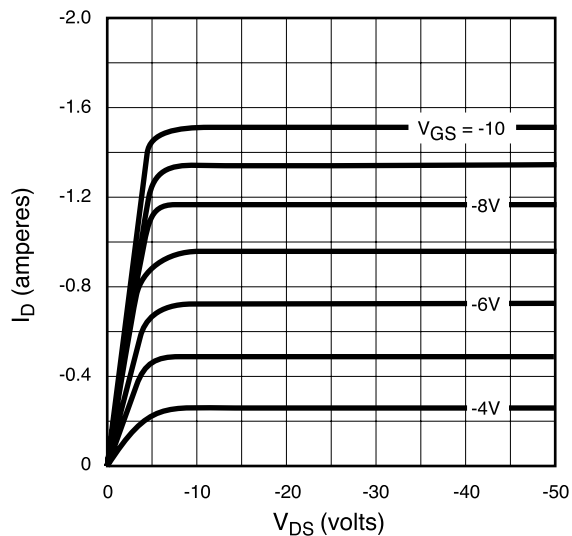

Saturation Characteristics

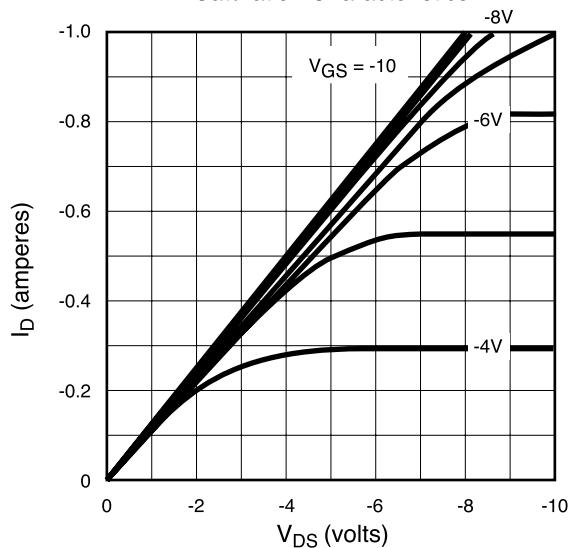

Transconductance vs. Drain Current

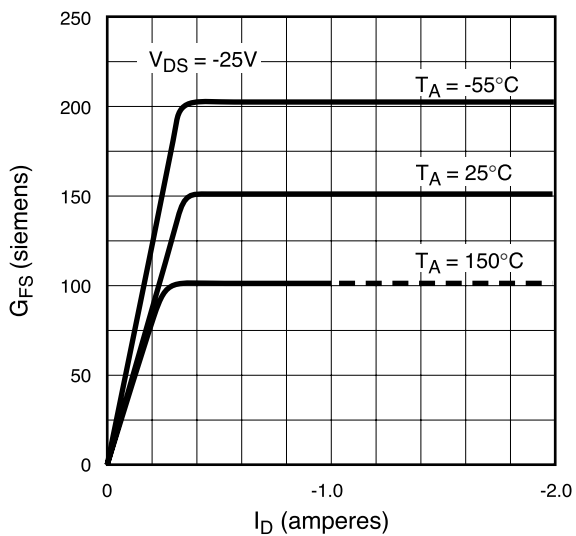

Power Dissipation vs. Case Temperature

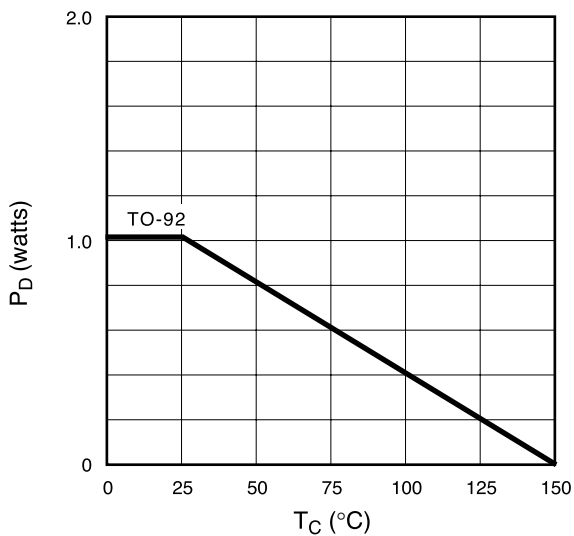

Maximum Rated Safe Operating Area

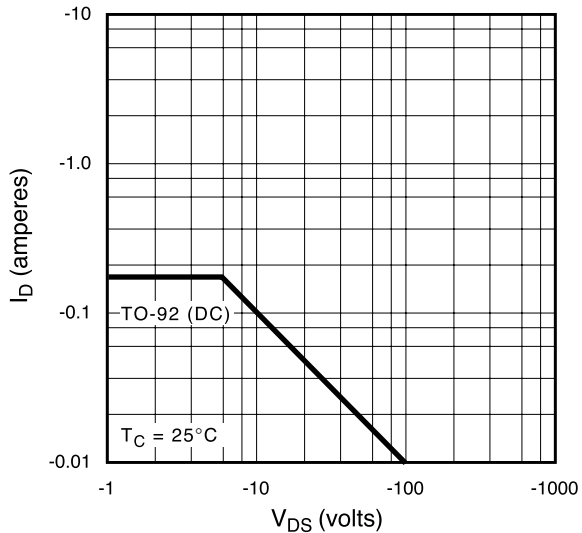

Thermal Response Characteristics

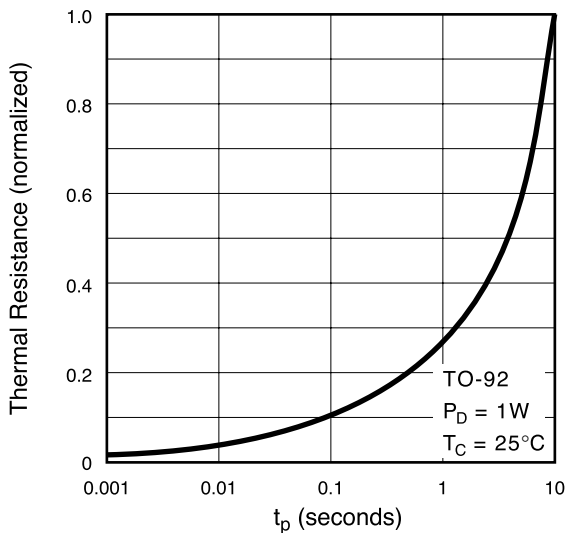

# Typical Performance Curves

BV<sub>DSS</sub> Variation with Temperature

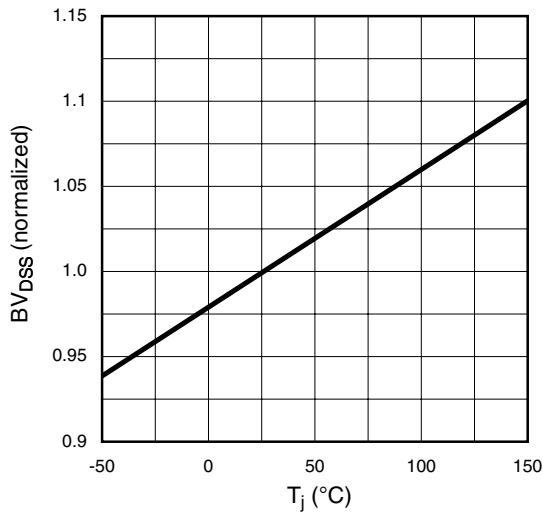

On-Resistance vs. Drain Current

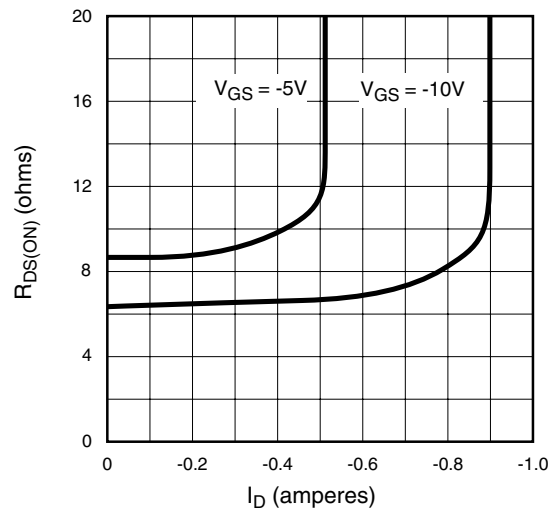

Transfer Characteristics

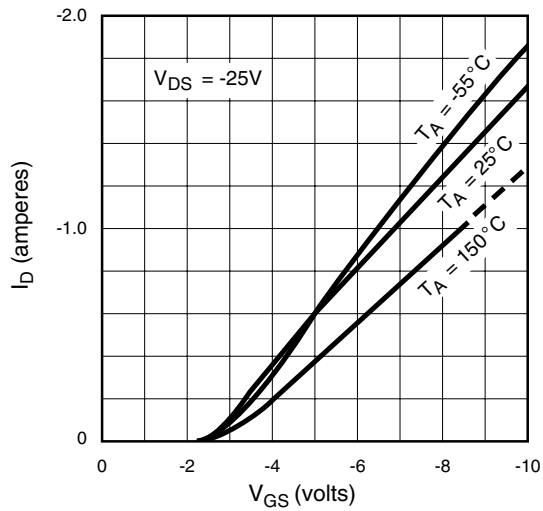

V<sub>(th)</sub> and R<sub>DS</sub> Variation with Temperature

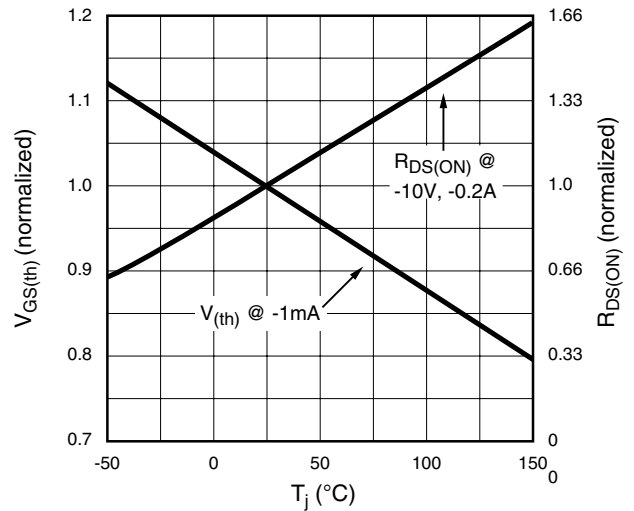

Capacitance vs. Drain-to-Source Voltage

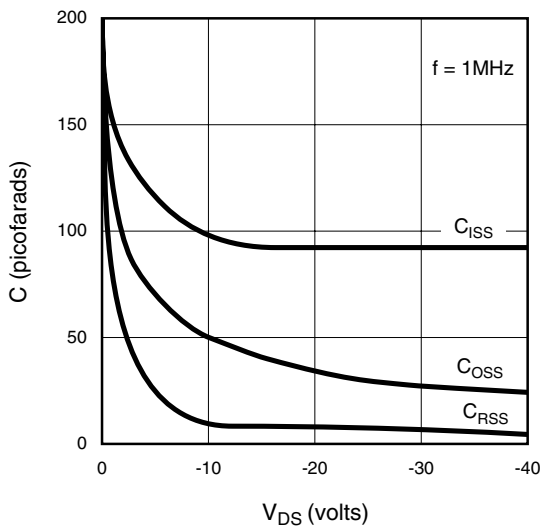

Gate Drive Dynamic Characteristics

