



## N-Channel Enhancement-Mode Vertical DMOS FETs

### Ordering Information

$BV_{DSS} /$ $BV_{DGS}$	$R_{DS(ON)}$ (max)	$I_{D(ON)}$ (min)	Order Number / Package
			TO-92
500V	60Ω	150mA	VN0550N3

### Features

- Free from secondary breakdown
- Low power drive requirement
- Ease of paralleling
- Low  $C_{ISS}$  and fast switching speeds
- Excellent thermal stability
- Integral Source-Drain diode
- High input impedance and high gain
- Complementary N- and P-channel devices

### Applications

- Motor controls
- Converters
- Amplifiers
- Switches
- Power supply circuits
- Drivers (relays, hammers, solenoids, lamps, memories, displays, bipolar transistors, etc.)

### Absolute Maximum Ratings

Drain-to-Source Voltage	$BV_{DSS}$
Drain-to-Gate Voltage	$BV_{DGS}$
Gate-to-Source Voltage	$\pm 20V$
Operating and Storage Temperature	-55°C to +150°C
Soldering Temperature*	300°C

\* Distance of 1.6 mm from case for 10 seconds.

### Advanced DMOS Technology

These enhancement-mode (normally-off) transistors utilize a vertical DMOS structure and Supertex's well-proven silicon-gate manufacturing process. This combination produces devices with the power handling capabilities of bipolar transistors and with the high input impedance and positive temperature coefficient inherent in MOS devices. Characteristic of all MOS structures, these devices are free from thermal runaway and thermally-induced secondary breakdown.

Supertex's vertical DMOS FETs are ideally suited to a wide range of switching and amplifying applications where high breakdown voltage, high input impedance, low input capacitance, and fast switching speeds are desired.

### Package Option

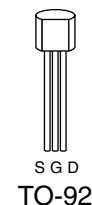

Note: See Package Outline section for dimensions.

## Thermal Characteristics

Package	$I_D$ (continuous)*	$I_D$ (pulsed)	Power Dissipation @ $T_C = 25^\circ\text{C}$	$\theta_{jC}$ $^\circ\text{C/W}$	$\theta_{ja}$ $^\circ\text{C/W}$	$I_{DR}^*$	$I_{DRM}$
TO-92	78mA	250mA	1.0W	125	170	78mA	250mA

\*  $I_D$  (continuous) is limited by max rated  $T_j$ .

## Electrical Characteristics (@ $25^\circ\text{C}$ unless otherwise specified)

Symbol	Parameter	Min	Typ	Max	Unit	Conditions
$BV_{DSS}$	Drain-to-Source Breakdown Voltage	VN0550	500		V	$V_{GS} = 0V, I_D = 1mA$
$V_{GS(th)}$	Gate Threshold Voltage	2		4	V	$V_{GS} = V_{DS}, I_D = 1mA$
$\Delta V_{GS(th)}$	Change in $V_{GS(th)}$ with Temperature		-3.8	-5.0	mV/ $^\circ\text{C}$	$V_{GS} = V_{DS}, I_D = 1mA$
$I_{GSS}$	Gate Body Leakage			100	nA	$V_{GS} = \pm 20V, V_{DS} = 0V$
$I_{DSS}$	Zero Gate Voltage Drain Current			10	$\mu\text{A}$	$V_{GS} = 0V, V_{DS} = \text{Max Rating}$
				1	mA	$V_{GS} = 0V, V_{DS} = 0.8 \text{ Max Rating}$ $T_A = 125^\circ\text{C}$
$I_{D(ON)}$	ON-State Drain Current		100		mA	$V_{GS} = 5V, V_{DS} = 25V$
		150	350			$V_{GS} = 10V, V_{DS} = 25V$
$R_{DS(ON)}$	Static Drain-to-Source ON-State Resistance		45		$\Omega$	$V_{GS} = 5V, I_D = 50mA$
			40	60		$V_{GS} = 10V, I_D = 50mA$
$\Delta R_{DS(ON)}$	Change in $R_{DS(ON)}$ with Temperature		1	1.7	%/ $^\circ\text{C}$	$V_{GS} = 10V, I_D = 50mA$
$G_{FS}$	Forward Transconductance	50	100		$\text{m}\overline{\text{S}}$	$V_{DS} = 25V, I_D = 50mA$
$C_{ISS}$	Input Capacitance		45	55	pF	$V_{GS} = 0V, V_{DS} = 25V$ $f = 1 \text{ MHz}$
$C_{OSS}$	Common Source Output Capacitance		8	10		
$C_{RSS}$	Reverse Transfer Capacitance		2	5		
$t_{d(ON)}$	Turn-ON Delay Time			10	ns	$V_{DD} = 25V,$ $I_D = 150mA,$ $R_{GEN} = 25\Omega$
$t_r$	Rise Time			15		
$t_{d(OFF)}$	Turn-OFF Delay Time			10		
$t_f$	Fall Time			10		
$V_{SD}$	Diode Forward Voltage Drop		0.8			
$t_{rr}$	Reverse Recovery Time		300		ns	$V_{GS} = 0V, I_{SD} = 0.5A$

### Notes:

- All D.C. parameters 100% tested at  $25^\circ\text{C}$  unless otherwise stated. (Pulse test: 300 $\mu\text{s}$  pulse, 2% duty cycle.)
- All A.C. parameters sample tested.

## Switching Waveforms and Test Circuit

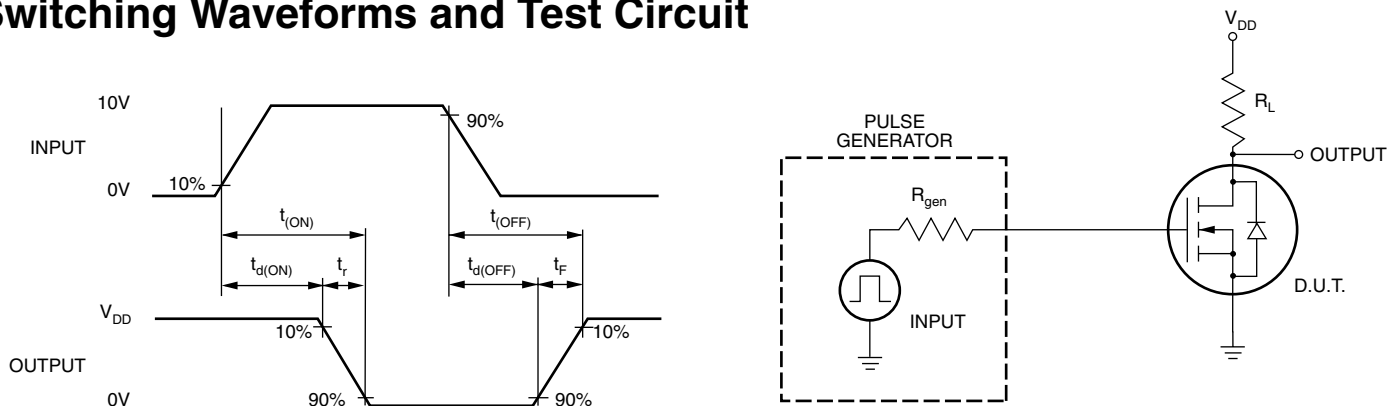

# Typical Performance Curves

Output Characteristics

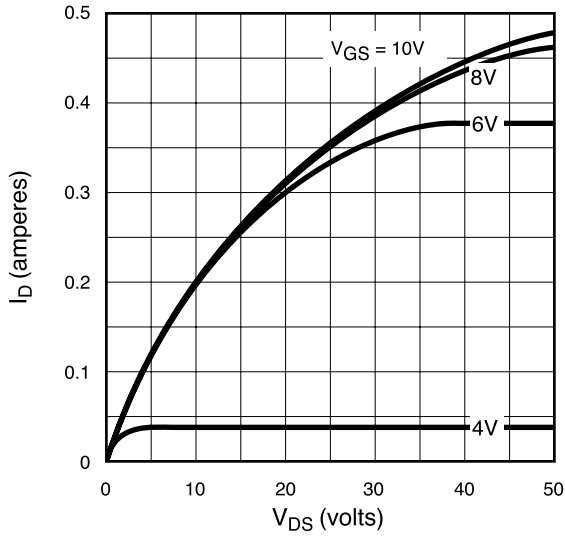

Saturation Characteristics

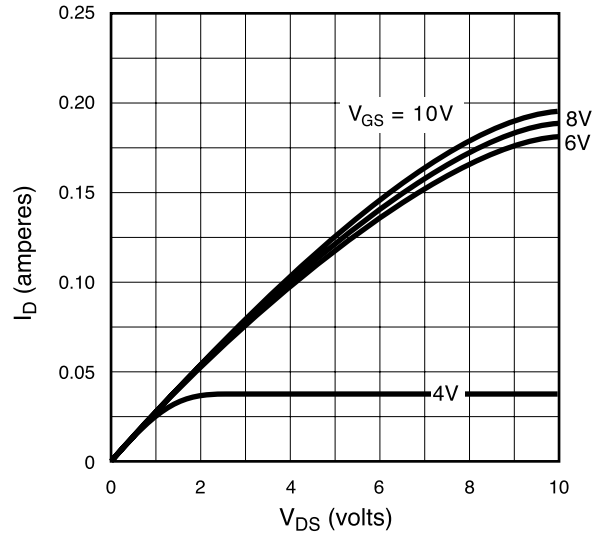

Transconductance vs. Drain Current

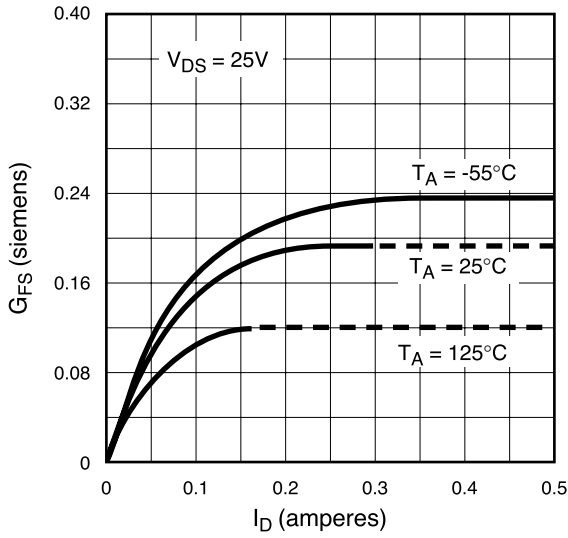

Power Dissipation vs. Case Temperature

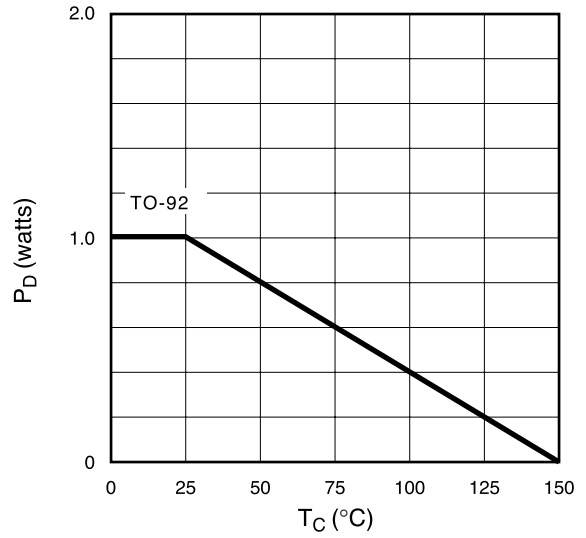

Maximum Rated Safe Operating Area

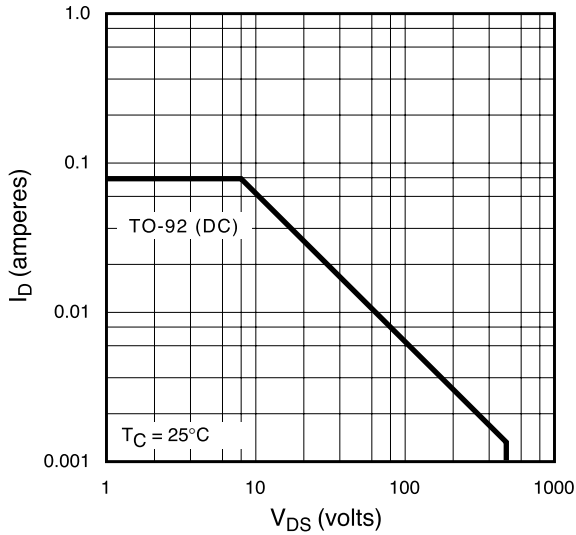

Thermal Response Characteristics

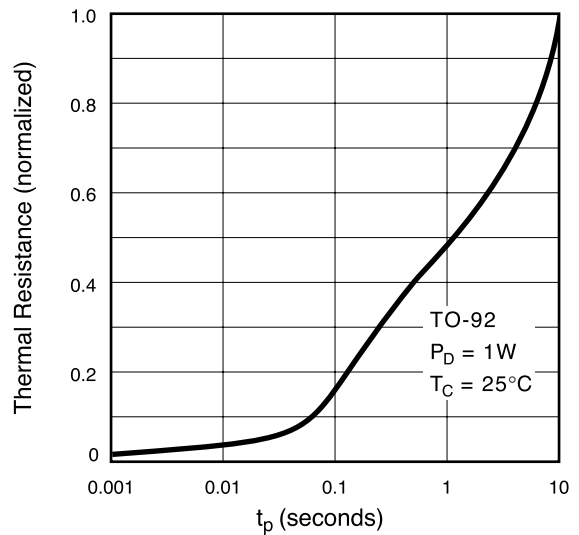

# Typical Performance Curves

BV<sub>DSS</sub> Variation with Temperature

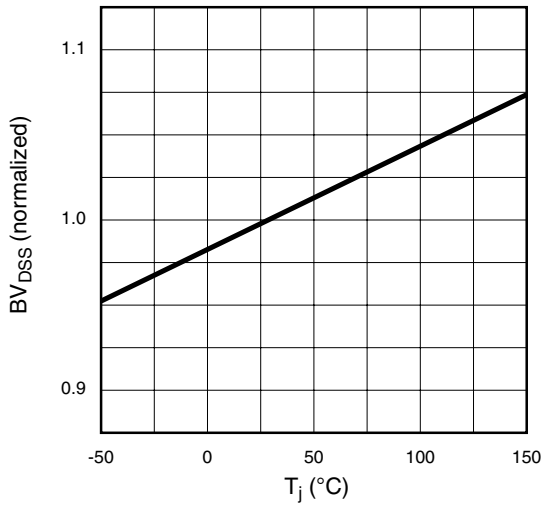

On-Resistance vs. Drain Current

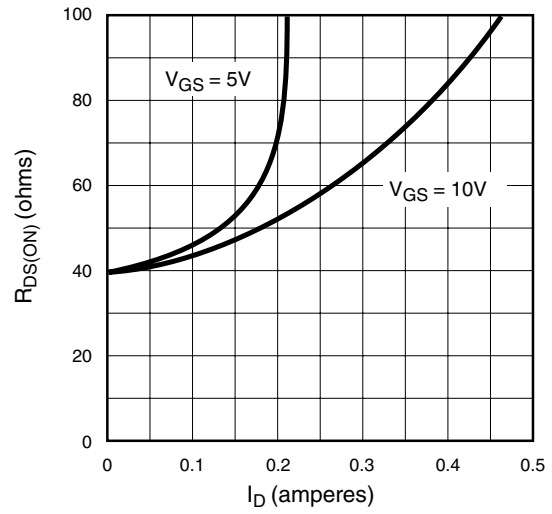

Transfer Characteristics

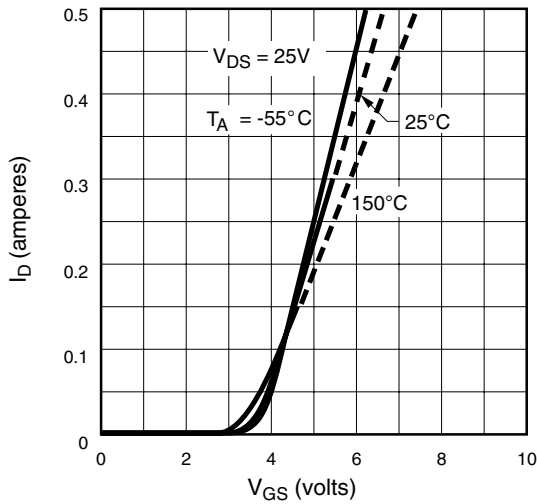

V<sub>(th)</sub> and R<sub>DS</sub> Variation with Temperature

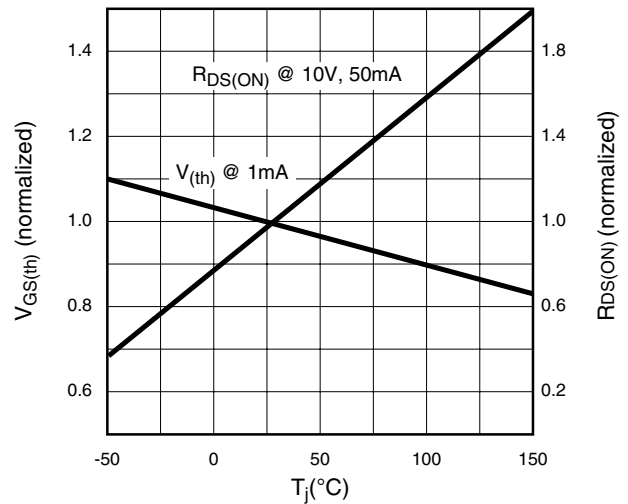

Capacitance vs. Drain-to-Source Voltage

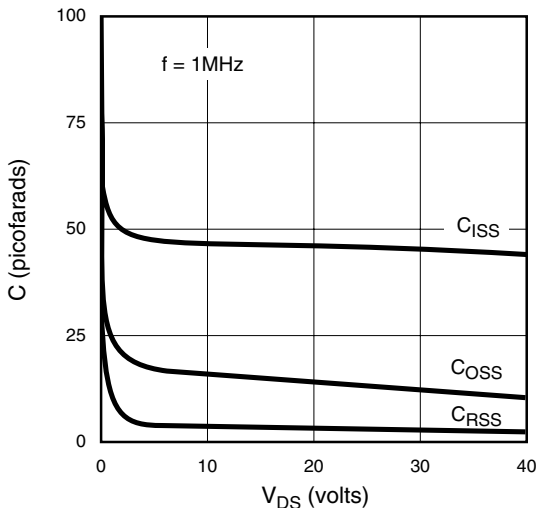

Gate Drive Dynamic Characteristics

