



## N-Channel Enhancement-Mode Vertical DMOS FETs

### Ordering Information

BV <sub>DSS</sub> / BV <sub>DGS</sub>	R <sub>DS(ON)</sub> (max)	I <sub>D(ON)</sub> (min)	Order Number / Package	
			TO-92	20-Pin C-Dip
220V	1.25Ω	5.0A	—	VN2222NC
240V	1.25Ω	5.0A	VN2224N3	—

### High Reliability Devices

See pages 5-4 and 5-5 for MILITARY STANDARD Process Flows and Ordering Information.

### Features

- Free from secondary breakdown
- Low power drive requirement
- Ease of paralleling
- Low C<sub>ISS</sub> and fast switching speeds
- Excellent thermal stability
- Integral Source-Drain diode
- High input impedance and high gain

### Applications

- Motor controls
- Converters
- Amplifiers
- Switches
- Power supply circuits
- Drivers (relays, hammers, solenoids, lamps, memories, displays, bipolar transistors, etc.)

### Absolute Maximum Ratings

Drain-to-Source Voltage	BV <sub>DSS</sub>
Drain-to-Gate Voltage	BV <sub>DGS</sub>
Gate-to-Source Voltage	± 20V
Operating and Storage Temperature	-55°C to +150°C
Soldering Temperature*	300°C

\* Distance of 1.6 mm from case for 10 seconds.

### Advanced DMOS Technology

These enhancement-mode (normally-off) transistors utilize a vertical DMOS structure and Supertex's well-proven silicon-gate manufacturing process. This combination produces devices with the power handling capabilities of bipolar transistors and with the high input impedance and positive temperature coefficient inherent in MOS devices. Characteristic of all MOS structures, these devices are free from thermal runaway and thermally-induced secondary breakdown.

Supertex's vertical DMOS FETs are ideally suited to a wide range of switching and amplifying applications where high breakdown voltage, high input impedance, low input capacitance, and fast switching speeds are desired.

### Package Options

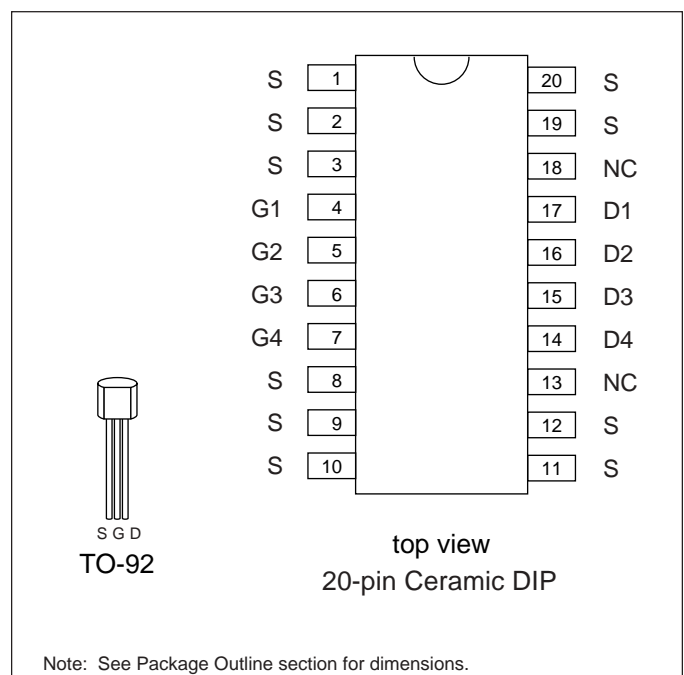

## Thermal Characteristics

Package	$I_D$ (continuous)*	$I_D$ (pulsed)	Power Dissipation @ $T_C = 25^\circ\text{C}$	$\theta_{jc}$ $^\circ\text{C/W}$	$\theta_{ja}$ $^\circ\text{C/W}$	$I_{DR}^*$	$I_{DRM}$
TO-92	540mA	5.0A	1.0W	125	170	540mA	5.0A

\*  $I_D$  (continuous) is limited by max rated  $T_j$ .

## Electrical Characteristics (@ $25^\circ\text{C}$ unless otherwise specified)

Symbol	Parameter	Min	Typ	Max	Unit	Conditions
$BV_{DSS}$	Drain-to-Source Breakdown Voltage	VN2224	240			V $V_{GS} = 0V, I_D = 5mA$
		VN2222	220			
$V_{GS(th)}$	Gate Threshold Voltage	1.0		3.0	V	$V_{GS} = V_{DS}, I_D = 5mA$
$\Delta V_{GS(th)}$	Change in $V_{GS(th)}$ with Temperature		-4	-5	mV/ $^\circ\text{C}$	$V_{GS} = V_{DS}, I_D = 5mA$
$I_{GSS}$	Gate Body Leakage		1	100	nA	$V_{GS} = \pm 20V, V_{DS} = 0V$
$I_{DSS}$	Zero Gate Voltage Drain Current			50	$\mu\text{A}$	$V_{GS} = 0V, V_{DS} = \text{Max Rating}$
				5	mA	$V_{GS} = 0V, V_{DS} = 0.8 \text{ Max Rating}$ $T_A = 125^\circ\text{C}$
$I_{D(ON)}$	ON-State Drain Current	2			A	$V_{GS} = 5V, V_{DS} = 25V$
		5	10			$V_{GS} = 10V, V_{DS} = 25V$
$R_{DS(ON)}$	Static Drain-to-Source ON-State Resistance		1.0	1.5	$\Omega$	$V_{GS} = 5V, I_D = 2A$
			0.9	1.25		$V_{GS} = 10V, I_D = 2A$
$\Delta R_{DS(ON)}$	Change in $R_{DS(ON)}$ with Temperature		1.0	1.4	%/ $^\circ\text{C}$	$V_{GS} = 10V, I_D = 2A$
$G_{FS}$	Forward Transconductance	1.0	2.2		$\bar{\Omega}$	$V_{DS} = 25V, I_D = 2A$
$C_{ISS}$	Input Capacitance		300	350	pF	$V_{GS} = 0V, V_{DS} = 25V$ $f = 1 \text{ MHz}$
$C_{OSS}$	Common Source Output Capacitance		85	150		
$C_{RSS}$	Reverse Transfer Capacitance		20	35		
$t_{d(ON)}$	Turn-ON Delay Time		6	15	ns	$V_{DD} = 25V$ $I_D = 2A$ $R_{GEN} = 10\Omega$
$t_r$	Rise Time		16	25		
$t_{d(OFF)}$	Turn-OFF Delay Time		65	90		
$t_f$	Fall Time		30	60		
$V_{SD}$	Diode Forward Voltage Drop		0.8	1.0	V	$V_{GS} = 0V, I_{SD} = 100mA$
$t_{rr}$	Reverse Recovery Time		500		ns	$V_{GS} = 0V, I_{SD} = 1A$

Notes:

- All D.C. parameters 100% tested at  $25^\circ\text{C}$  unless otherwise stated. (Pulse test: 300 $\mu\text{s}$  pulse, 2% duty cycle.)
- All A.C. parameters sample tested.

## Switching Waveforms and Test Circuit

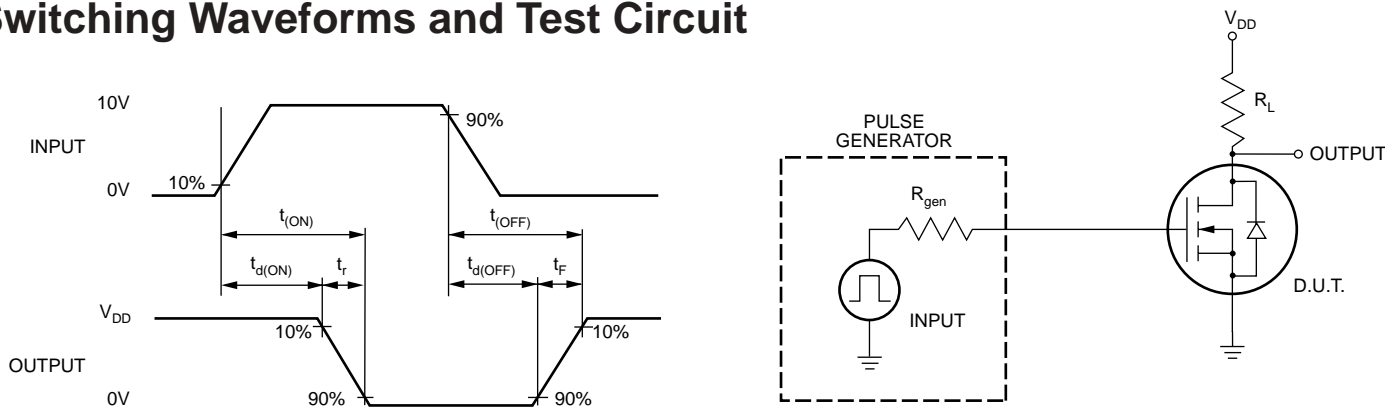

# Typical Performance Curves

Output Characteristics

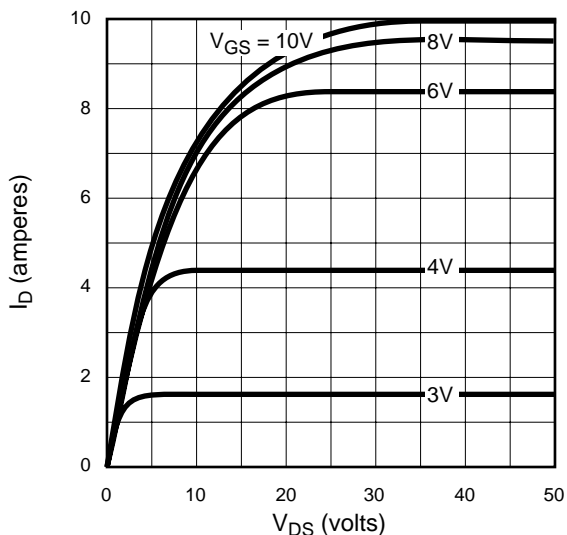

Saturation Characteristics

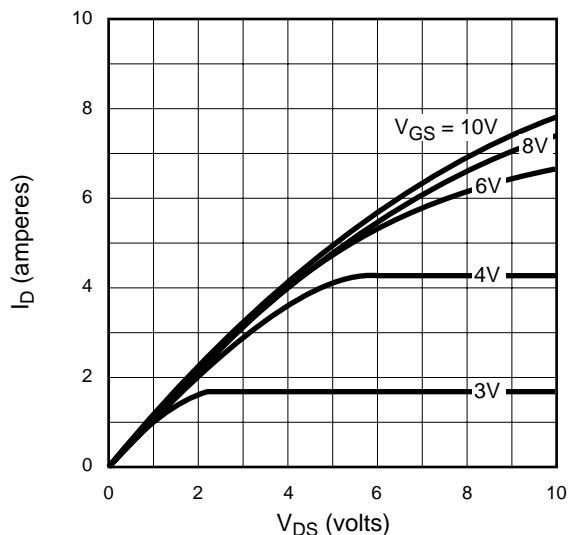

Transconductance vs. Drain Current

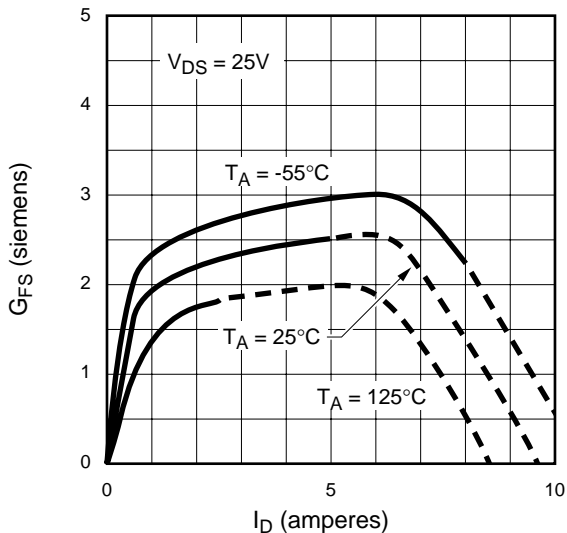

Power Dissipation vs. Case Temperature

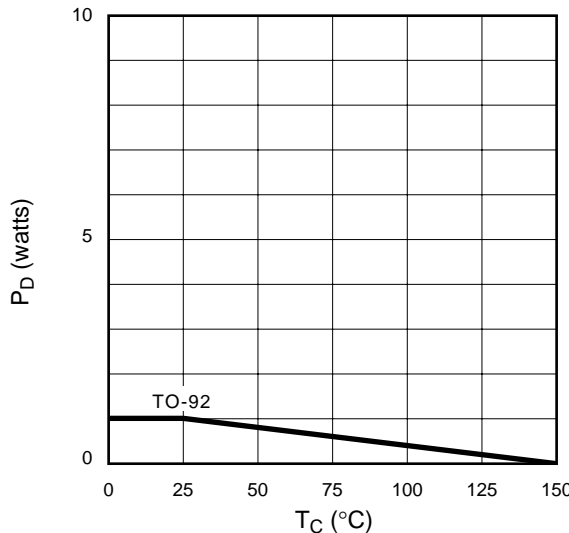

Maximum Rated Safe Operating Area

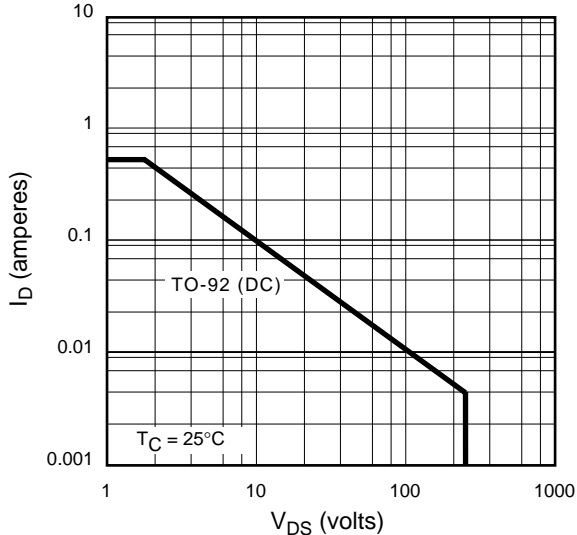

Thermal Response Characteristics

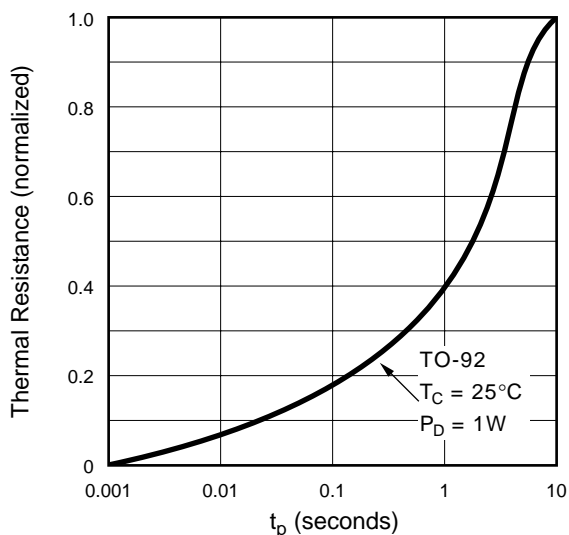

# Typical Performance Curves

BV<sub>DSS</sub> Variation with Temperature

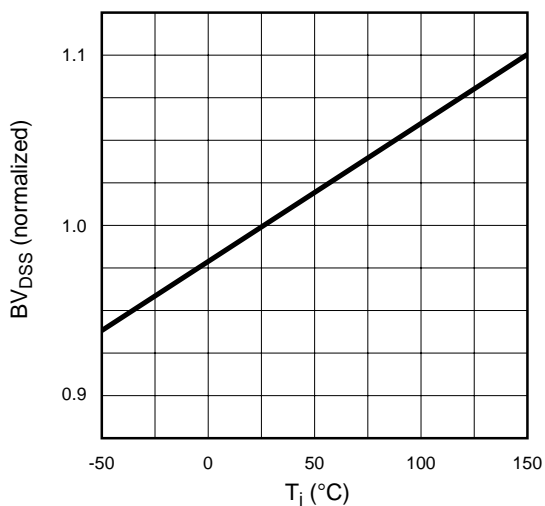

On-Resistance vs. Drain Current

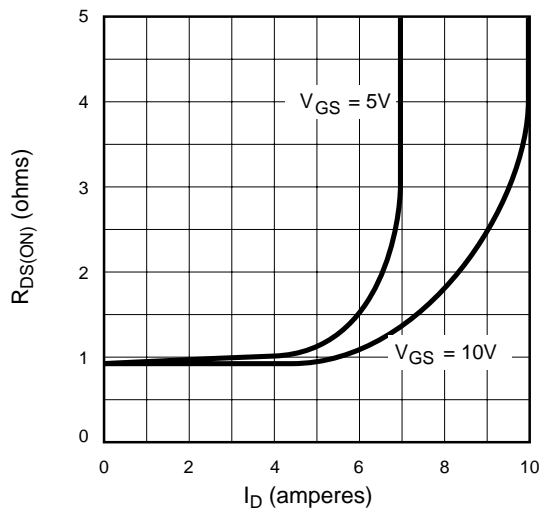

Transfer Characteristics

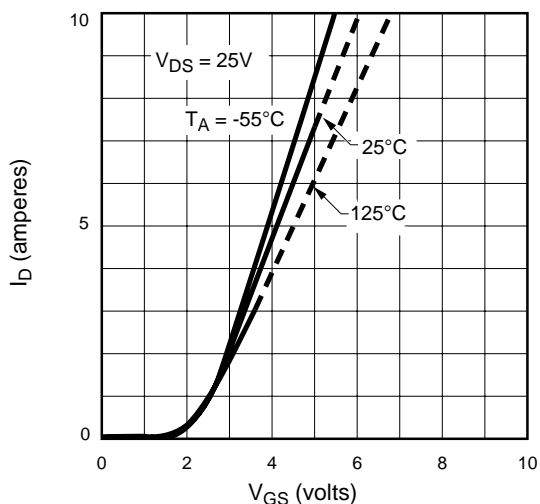

V<sub>(th)</sub> and R<sub>DS</sub> Variation with Temperature

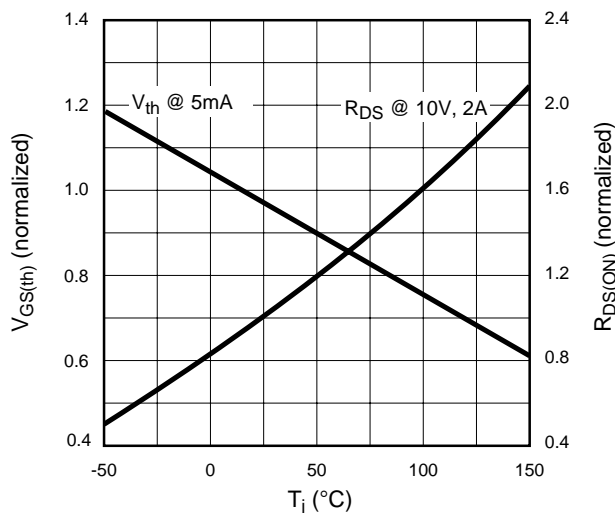

Capacitance vs. Drain-to-Source Voltage

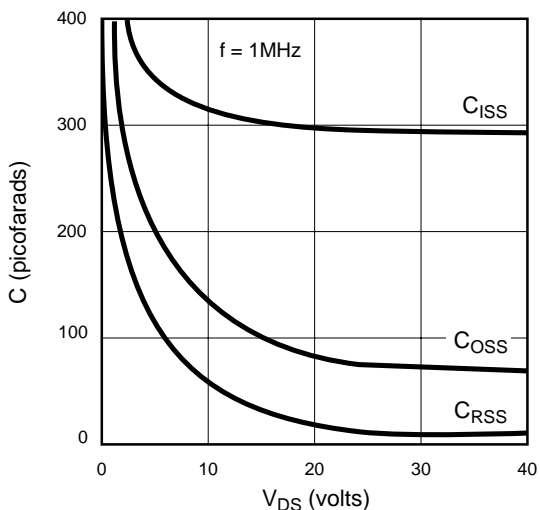

Gate Drive Dynamic Characteristics

